

General tolerances ISO 2768-m						Index	Date	Visum	Modification	Index	Date	Visum	Modification
Basic-size	...6	> 6 ...30	> 30 ...120	>120 ...400	> 400 ...1000								
medium	±0.1	±0.2	±0.3	±0.5	±0.8								

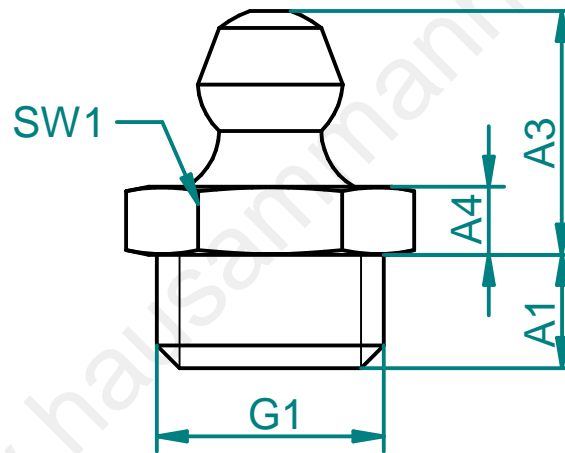

Specifications points D,K,H	
D= doc.points	
K= critical	
H= main	

		Material:															
		Stahl verzinkt															
		Scale															
		3:1															
		<table border="1"> <tr> <td></td> <td>Date</td> <td>Visum</td> <td>Phone</td> </tr> <tr> <td>plotted</td> <td>26.09.11</td> <td>E.Z</td> <td></td> </tr> <tr> <td>checked</td> <td></td> <td></td> <td></td> </tr> </table>			Date	Visum	Phone	plotted	26.09.11	E.Z		checked					
	Date	Visum	Phone														
plotted	26.09.11	E.Z															
checked																	
		06.005															
		Solid Edge		Format Index													
		A4		00													
<small>Accord-draw.no.: Origin-draw.no.: Replacement for:</small>		HAUSAMMANN KOMponenten PRODUKTION SYSTEME		<small>© 2010, Für dieses Dokument behalten wir uns alle Rechte vor. © 2 010, Nous nous reservons tous les droits sur ce document © 2 010, We reserve all rights in connection with this document</small>													